

REVELATION

by UTTERMOST

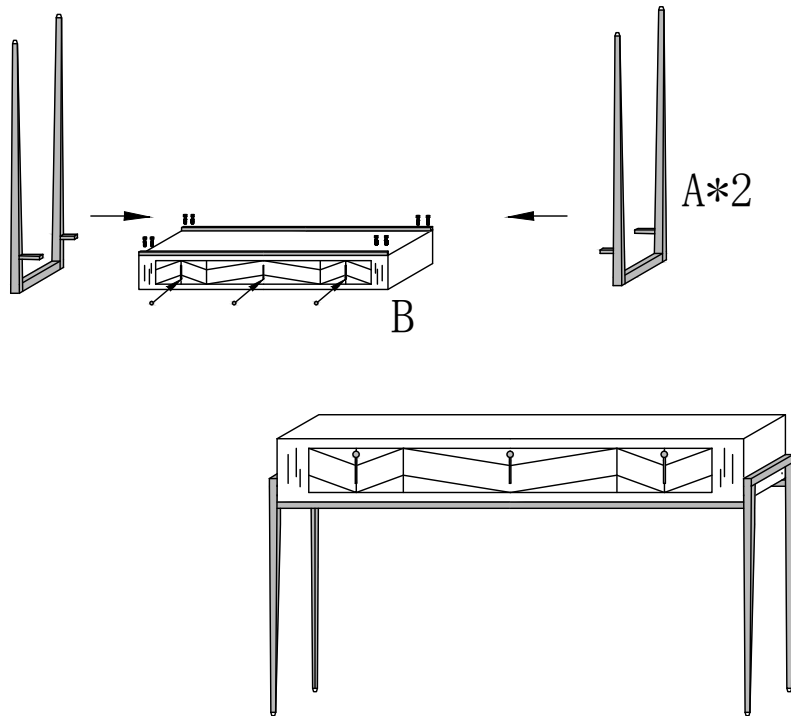







Assembly Instruction

R24894

1. Take the parts carefully out of the carton, and place it on a flat surface, make sure that the parts will not be damaged.
2. Place part B on flat ground conversely.
3. Lock part A to the side of part B by allen screws.
4. Take out the handles out of the hardware bag , and fix them on the drawers.

Hardware and tool included: allen screws, allen wrench, washers, screws, handles.

To clean, wipe with soft dry cloth.

		 2cm	 1cm		
x1	x8	x8	x3	x3	x3